

Pipercross airfilter

PX600 serie

High performance air filter for twin side draught carburettors or throttle bodies

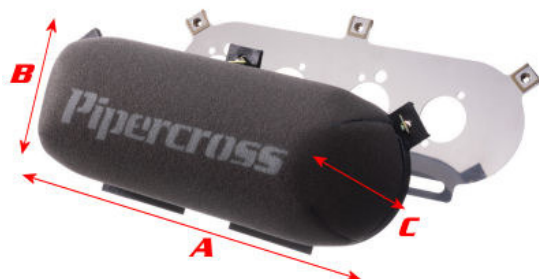

- available in 2 different models
- L x W = 435 x 190mm
- with standard base plate (without holes)



P/N	Length (A)	Width (B)	Overall Height (C)	Internal Height (D)	
C602D	435mm	190mm	90mm	65mm	domed
C603D	435mm	190mm	120mm	90mm	domed
C604D	435mm	190mm	150mm	125mm	domed
C6001	435mm	190mm	40mm	25mm	box
C6002	435mm	190mm	55mm	40mm	box
C6003	435mm	190mm	80mm	65mm	box
C6004	435mm	190mm	115mm	100mm	box
C6006	Standard base plate (blank without holes)				
ABB2/50	Airbox backplate (Jenvey)				

PX300

High performance air filter for carburettors or throttle bodies

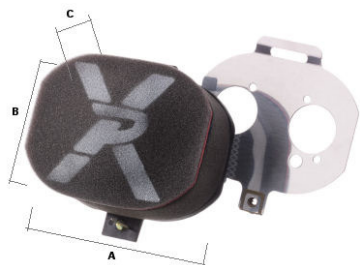

- available in 2 different models
- L x W = 190 x 190mm
- with standard base plate (without holes)



Pipercross airfilters

P/N	Length (A)	Width (B)	Overall Height (C)	Internal Height (D)	
C302D	190mm	190mm	65mm	40mm	domed
C303D	190mm	190mm	90mm	65mm	domed
C304D	190mm	190mm	125mm	100mm	domed
C3001	190mm	190mm	40mm	25mm	box
C3002	190mm	190mm	55mm	40mm	box
C3003	190mm	190mm	80mm	65mm	box
C4004	190mm	190mm	115mm	100mm	box
C3119	Standard base plate (blank without holes)				

PX700 serie

- Lightweight performance airfilter
- Increased air flow
- Maximum torque & BHP
- Outer Ø 56-83mm

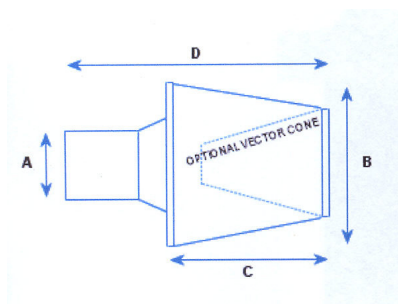

P/N	Outer Ø (A) in mm	Outer Ø (B) in mm	Filter Height (C) in mm	Total Length inc neck (D)	
Vector					
C7021	C7021V	53	150	150	215
C7016	C7016V	56	150	150	252
C7022	C7022V	60	150	150	260
C7001	C7001V	63	150	150	215
C7002	C7002V	63	200	150	235
C7017	C7017V	65	150	150	215
C7015	C7015V	68	150	150	290
C7023	C7023V	68	150	150	240
C7010	C7010V	71	150	150	220
C7018	C7018V	71	150	150	260
C7028	C7028V	71	200	110	190

Pipercross airfilters

P/N		Outer Ø (A) in mm	Outer Ø (B) in mm	Filter Height (C) in mm	Total Length inc neck (D)
	Vector				
C7009	C7009V	71	200	150	235
C7020	C7020V	74	150	150	190
C7025	C7025V	76	150	150	220
C7005	C7005V	76	200	150	235
C7004	C7004V	83	150	150	265
C7024	C7024V	88,5	150	150	190
C7027	C7027V	100	200	110	190

C-Serie

- Performance airfilter
- Inner Ø 50-146mm



P/N	Inner Ø (A) in mm	Outer Ø (B) in mm	Filter Height (C) in mm	BHP
C0186	50	100	150	100
C0179	60	150	200	200
C0172	60	200	200	250
C0173	65	150	200	250
C0171	70	100	200	210
C0176	70	150	200	270
C0177	70	200	200	320
C1223	73	150	150	200
C0182	75	150	200	290
C0187	80	200	200	380
C0183	85	150	200	340
C0630	90	150	200	355
C0640	100	150	200	360
PK009F	100	100	150	250
C0181	110	150	190	250
C0174	146	200	250	500

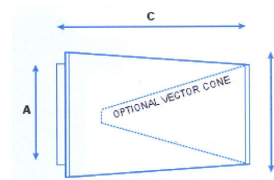

Pipercross airfilters

PK...V

- Performance airfilter with outer cage
- Inner Ø 60-100mm



P/N	Inner Ø (A) in mm	Outer Ø (B) in mm	Filter Height (C) in mm	BHP
PK001V	60	100	150	110
PK002V	65	100	150	135
PK003V	70	100	150	150
PK004V	75	100	150	170
PK005V	80	100	150	195
PK006V	85	100	150	215
PK007V	90	100	150	234
PK009V	100	100	100	150

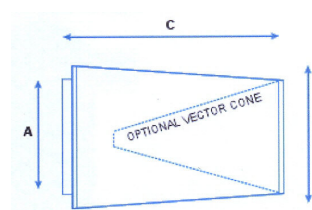

Trumpet socks

- designed to fit over airhorns
- ideal for applications where clearance is a problem



P/N	Description
C1050	Universel
C1053	for Off-Road



Pipercross airfilters

Airbox (600 Serie)

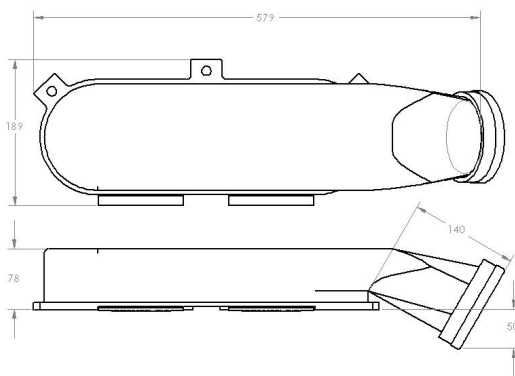
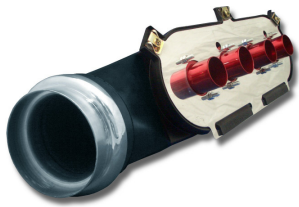

- available in both left and right hand fitments and 75 or 100mm bell mouth
- designed to fit directly to all 600 baseplates

P/N	Ø connection
C6275 LH	75, left
C6275 RH	75, right
C6200 LH	100, left
C6200 RH	100, right

Filter Cleaning Kits

P/N	Description
C9003	Cleaner 500ml
C9004	Cleaner 500ml + oil 500ml
C9005	Cleaner 75ml + oil 75ml

