



WIRING SCHEMATIC  
FOR S60PRO

LAST UPDATED  
18/11/2014

NEEDS FIRMWARE  
V77.00 AND HIGHER  
FOR ALL OPTIONS

Tel +44 (0)161 877 1419  
Fax +44 (0)161 877 7086  
Email office@dtafast.co.uk

**S60PRO Power Connections**  
Drawn from pin insertion side  
Note this connector has Three  
keyways in total

Fused 12V

For Firing Order  
1 3 4 2 Cyl Numbers  
In Green

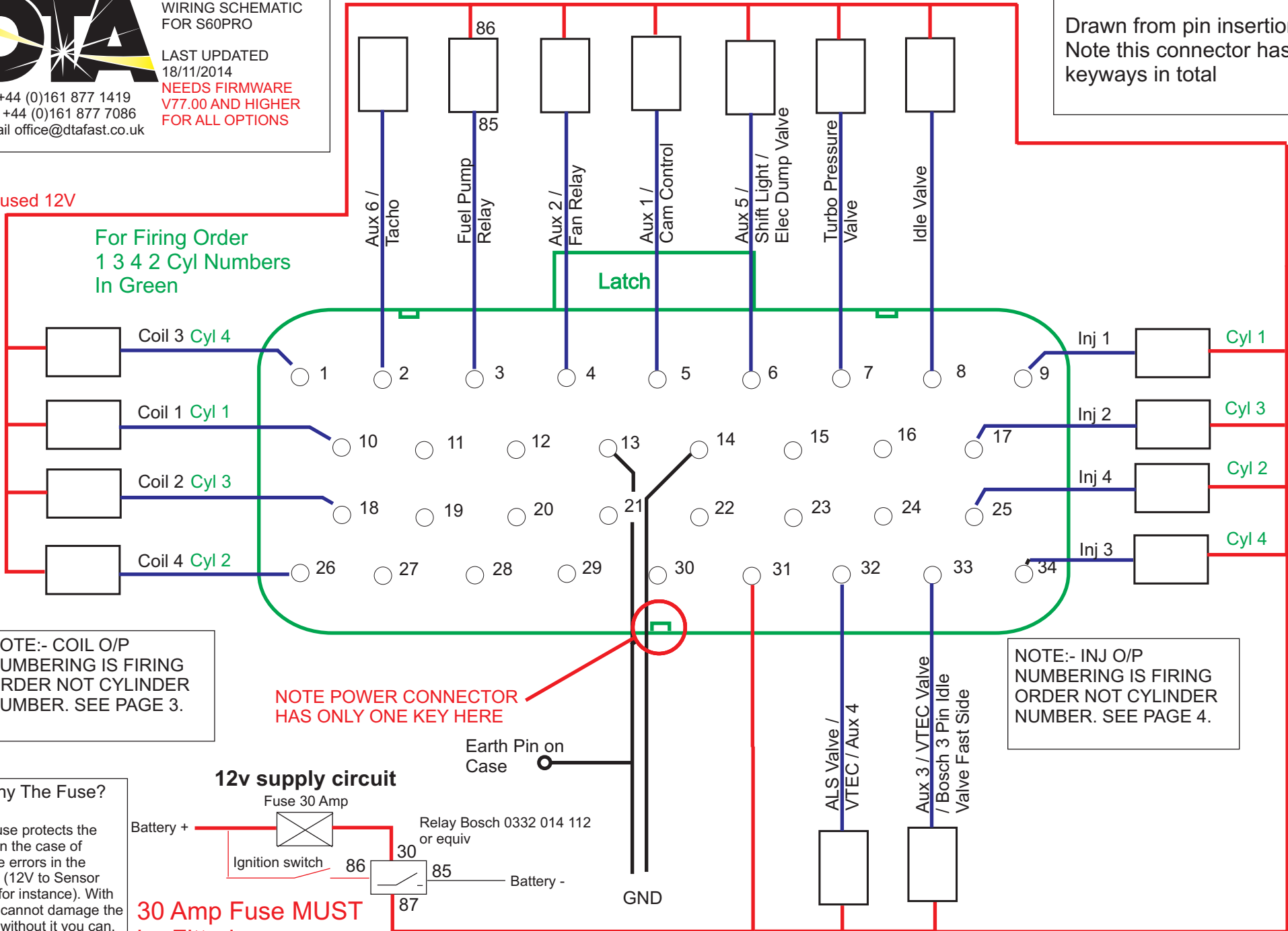

NOTE:- COIL O/P  
NUMBERING IS FIRING  
ORDER NOT CYLINDER  
NUMBER. SEE PAGE 3.

NOTE POWER CONNECTOR  
HAS ONLY ONE KEY HERE

NOTE:- INJ O/P  
NUMBERING IS FIRING  
ORDER NOT CYLINDER  
NUMBER. SEE PAGE 4.

**Why The Fuse?**  
The fuse protects the ECU in the case of severe errors in the wiring (12V to Sensor GND for instance). With it you cannot damage the ECU, without it you can. The choice is yours.

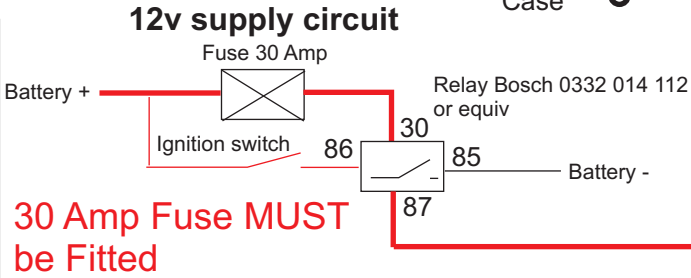

**30 Amp Fuse MUST  
be Fitted**

Fused 12V

## S60PRO Sensor Connections

Drawn from pin insertion side  
 Note this connector has four  
 keyways in total

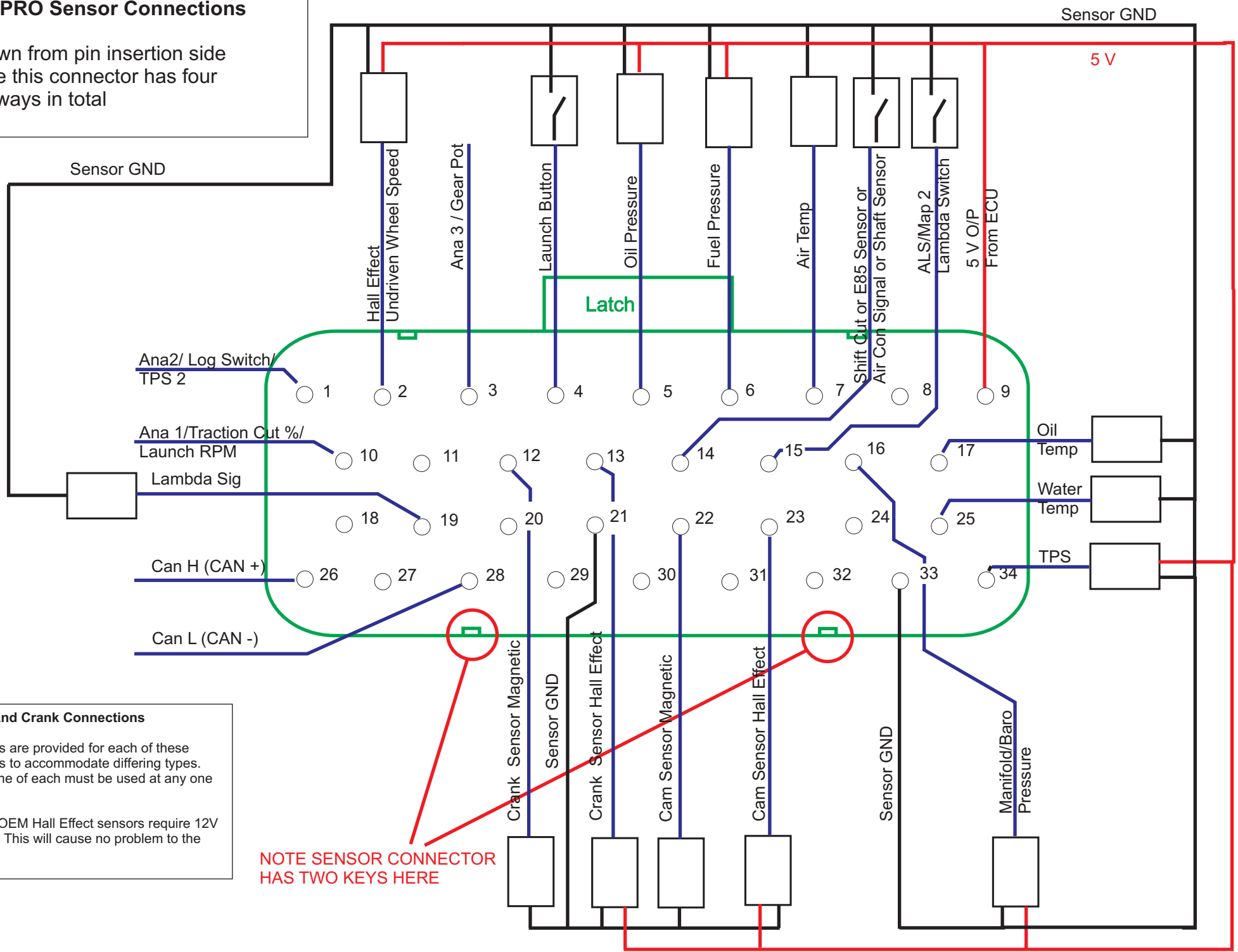

## Cam And Crank Connections

2 inputs are provided for each of these sensors to accommodate differing types. Only one of each must be used at any one time.

Some OEM Hall Effect sensors require 12V supply. This will cause no problem to the ECU.

NOTE SENSOR CONNECTOR HAS TWO KEYS HERE

## Sensor Connections

### Crank sensor connections

Use twisted pair wire with overall screen for crank sensor

#### VR sensor pin outs (magnetic)

##### Ford inc Duratec

Pin 1 to pin 12

Pin 2 to Sensor GND

Shield to Sensor GND at ECU

##### Vauxhall/Opel/BMW/Volvo/Saab/ etc. (Bosch & Siemens)

Pin 1 to pin 12

Pin 2 to pin Sensor GND

Pin 3 to shield to Sensor GND at ECU

##### Marelli

Pin 2 to pin 12

Pin 1 to Sensor GND

Shield to Sensor GND at ECU

### Manifold Pressure Sensors

GM Map

A = Sensor GND

B = Signal

C = 5 Volt

Bosch Map 0261 230 004

1 = 5 Volt

2 = GND

3 = Signal

Marrelli Map

A = 5V

B = Sensor GND

C = Signal

### Throttle pot

Connect 5 v to side to which throttle wiper goes at full open

any value 500 Ohm to 20 K Ohm

Colvern (Jenvey) pot

Red = Wiper

Green or Blue = 5v

Yellow or Black = Sensor GND

All 5 volt and Sensor Gnd connections are equivalent (except Lambda Gnd). Use the ones which are most suitable for the sensors connected. If not using twisted pair wire, twist together separate wires a pitch of approx. 2.5 cm

### ANALOGUE 2 WIRING FOR LOG SWITCH

If using the analogue 2 input for switching the log on and off use the following wiring.

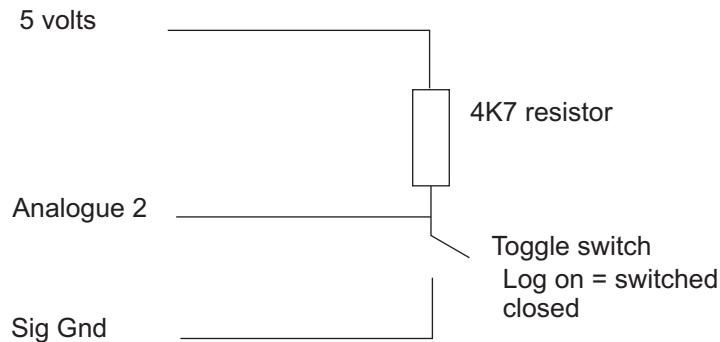

### Serial Port Connections

1 -> 1

2 -> 2

3 -> 3 9 - 15 pin (Dyno Control Box uses the rest)

4 -> 4

5 -> 5

### Flash Programming Switch

8

13

### Output Driver Limitations

All Auxilliaries Unless otherwise stated 1 Amp

ALS Valve 4 Amp

Aux 3 4 Amp

Injector Drivers 4 Amp

Coil Drivers 9 amp

## Coil Wiring

### Coil Per Plug

Remember that the outputs are numbered in firing sequence, that is 1 is the first to fire, 2 the second etc. For a 4 cylinder with a firing sequence of 1/3/4/2 connect wires as below. A cam sensor MUST be fitted for coil per plug operation.

|     |   |   |   |   |
|-----|---|---|---|---|
| Cyl | 1 | 3 | 4 | 2 |
| O/P | 1 | 2 | 3 | 4 |

And similarly for 6 or 8 cylinder engines.

### Wasted Spark

Use the lowest outputs. For a 6 cylinder engine with a firing order of 1/3/6/4/5/2 wire as below.

|     |   |   |   |
|-----|---|---|---|
| Cyl | 1 | 3 | 6 |
| Cyl | 4 | 5 | 2 |
| O/P | 1 | 2 | 3 |

### Distributor

Use Coil output 1..

### Twin Spark

Coil O/P's 1 to 2 work as normal. Coil O/P's 3 to 4 are the matching second plug. For a 4 cylinder, wasted spark,, twin spark wire as below.

|     |       |       |            |
|-----|-------|-------|------------|
| Cyl | 1 & 4 | 2 & 3 | First Plug |
| O/P | 1     | 2     |            |

|     |   |   |             |
|-----|---|---|-------------|
| Cyl | 1 | 3 | Second Plug |
| O/P | 3 | 4 |             |

Four cylinder cylinder wasted spark is the maximum for twin spark operation.

## Injector Wiring

**Note all injectors must be high impedance types or use a ballast resistor.**

### Sequential

Remember that the outputs are numbered in firing sequence, that is 1 is the first to fire, 2 the second etc. For a 4 cylinder with a firing sequence of 1/3/4/2 connect wires as below.

|     |   |   |   |   |
|-----|---|---|---|---|
| Cyl | 1 | 3 | 4 | 2 |
| O/P | 1 | 2 | 3 | 4 |

A cam sensor MUST be fitted for sequential injection.

### Non Sequential

Use O/P's 1,2,3 & 4 to any injector

### Non Sequential Twin Injector

Injectors 1:- Use O/P's 1,2. Wire equal numbers of injectors on each if possible

Injectors 2:- Use O/P's 3,4. Wire equal numbers of injectors on each if possible.

## Special Nissan Connections

Connections for combined Nissan/Denso Cam Shaft mounted sensor system.  
Engine codes RB25, RB26, RB20.  
General Engine Settings, Flywheel Mode 5

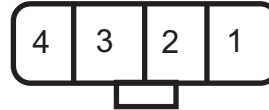

- 1 - TDC Signals - White
- 2 - 360 degree signal - Green
- 3 - +5V - Red
- 4 - Signal GND - Black

**Note:- Before Firmware V49.02 Connect TDC signal to Undriven wheel speed on the ECU sensor connector, after V49.02 the normal Cam input.** Connect 360 degree signal to normal hall effect crank shaft sensor input Pin 13

**The connector is drawn looking at the sensor output.**

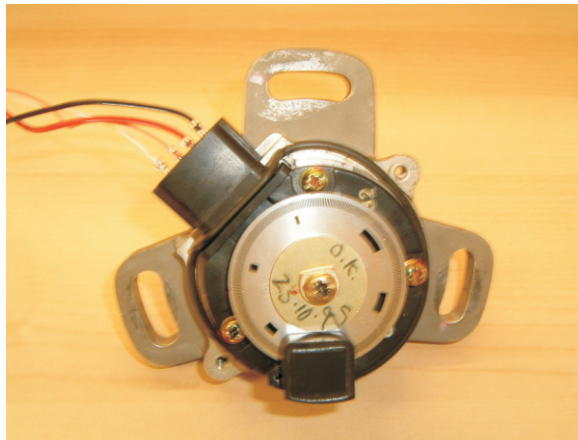

This sensor comes in 4 and 6 cylinder versions, either is acceptable.

## Special Nissan Connections

Connections for combined Nissan/Denso Cam Shaft mounted sensor system.  
Engine Code SR20.  
General Engine Settings, Flywheel Mode 8

**We have seen various connectors on this one but the wire colours are always the same**

- 1 - TDC Signals - White
- 2 - 360 degree signal - Green
- 3 - +5V - Red
- 4 - Signal GND - Black

**Note:- Before Firmware V49.02 Connect TDC signal to Undriven wheel speed on the ECU sensor connector, after V49.02 the normal Cam input.** Connect 360 degree signal to normal hall effect crank shaft sensor input Pin 13



Alternative Connector

1 = GND, 2 = 5V, 3 = 360 Deg, 4 = TDC

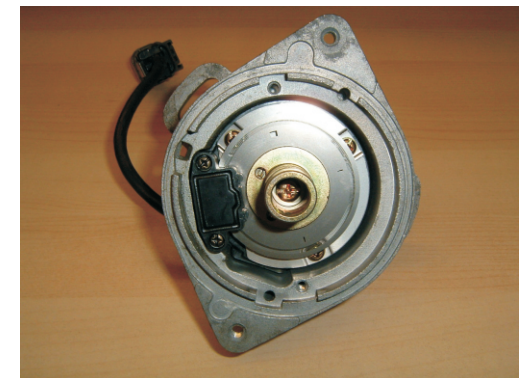

This sensor comes in 4 and 6 cylinder versions, Only the 4 cylinder version is acceptable.

## VDO Pressure Adapter Connections

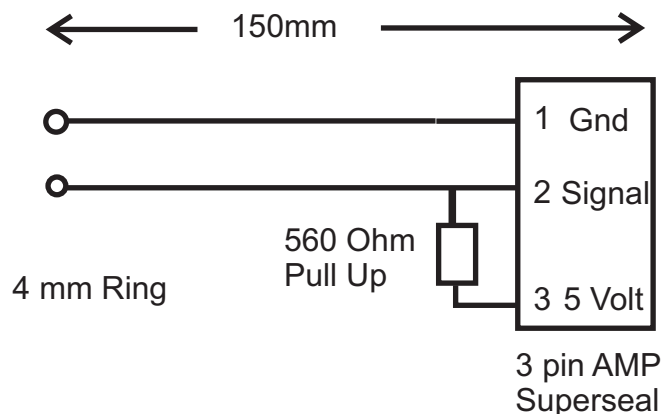

## Honda K20A

### LOAD K20A MAP BEFORE CONNECTING COILS

#### General Engine Settings, Flywheel Mode 7.

Connect Inlet Cam Sensor to Pin 2. Exhaust cam sensor to normal cam input, Pin 23. Crank to Pin 13.

All drawn looking at the sensor/actuator  
**Sensor Connections**

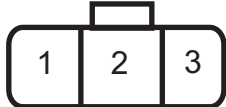

#### Crank and Cam Sensor

Pin 1 = Signal  
Pin 2 = Sensor GND  
Pin 3 = 12V

#### TPS

Pin 1 = Sensor GND  
Pin 2 = Signal  
Pin 3 = 5V

#### MAP

Pin 1 = 5V  
Pin 2 = Signal  
Pin 3 = Sensor GND

#### Power Connections

##### Idle Valve

Pin 1 = GND  
Pin 2 = 12V  
Pin 3 = Signal

#### Coil Connections



Pin 1 = Signal  
Pin 2 = GND  
Pin 3 = 12V

#### Connect VTEC Valve to AUX3

The Vtec Valve is on the exhaust side of the engine, inlet adjustment valve on the front

## Honda F20C (S2000)

### LOAD S2000 MAP BEFORE CONNECTING COILS

#### General Engine Settings, Flywheel Mode 9.

Connect exhaust cam sensor to normal cam input, Pin 22. Crank to Pin 12.

All drawn looking at the sensor/actuator  
**Sensor Connections**

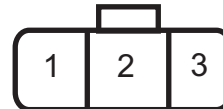

#### Crank Sensor

Pin 1 = Signal  
Pin 2 = Sensor GND  
Pin 3 = Shield

#### Ex. Cam Sensor (2 pin)

Pin 1 = Signal  
Pin 2 = GND

#### TPS

Pin 1 = Sensor GND  
Pin 2 = Signal  
Pin 3 = 5V

#### MAP

Pin 1 = 5V  
Pin 2 = Signal  
Pin 3 = Sensor GND

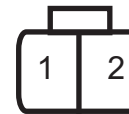

#### Power Connections

##### Idle Valve

Pin 1 = GND  
Pin 2 = 12V  
Pin 3 = Signal

#### Coil Connections

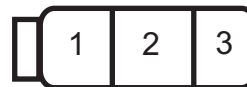

Pin 1 = Signal  
Pin 2 = GND  
Pin 3 = 12V

#### Connect VTEC Valve to AUX3 Via Relay

## Honda B16 & B18 Distributor

#### General Engine Settings, Flywheel Mode 6.

Connect cam sensor to cam input, Pin 22. Crank to Pin 12.

### Requires Firmware V17.02 or Higher

All drawn looking at the sensor/actuator

#### Distributor Connections

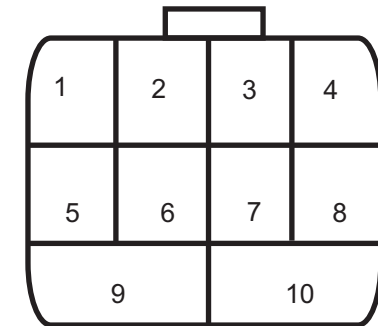

#### Crank Sensor

Pin 2 = Signal  
Pin 6 = Sensor GND

#### Cam Sensor

Pin 8 = Signal  
Pin 4 = Sensor GND

#### Coil Trigger

Pin 1

#### Tacho

Pin 9

#### 12V

Pin 10

#### Connect VTEC Valve to AUX3 Via Relay

## Suzuki GSXR 1000 K5 & K6

All drawn looking at the sensor/actuator

Crank Sensor

Pin 1 Signal (Black)  
Pin 2 GND (Green)

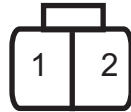

## Rover 1800 K VVC Connector Pin Outs

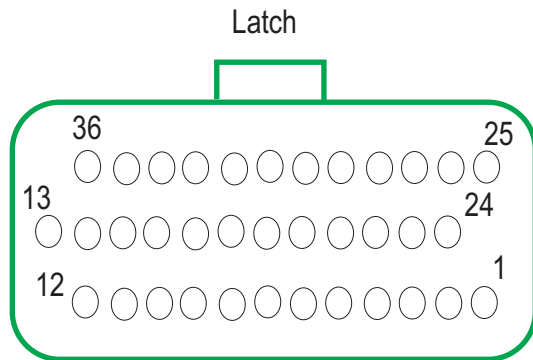

Drawn From ECU Side of Loom Connector  
on Vehicle

## Rover 1800 K VVC Loom to S60

Rover Red Connector      S60 Pin

|             |           |
|-------------|-----------|
| 1 Cam+      | 22 Sensor |
| 2 Cam-      | 21 Sensor |
| 9 Tacho Out | 2 Power   |
| 12 INJ 1    | 9 Power   |
| 13 INJ 2    | 25 Power  |
| 14 INJ 3    | 17 Power  |
| 25 Crank+   | 12 Sensor |
| 26 Crank-   | 21 Sensor |
| 27 Lambda+  | 19 Sensor |
| 28 Lambda-  | 18 Sensor |
| 35 INJ 4    | 34 Power  |

Rover Black Connector      S60 Pin

|                       |                |
|-----------------------|----------------|
| 2 VVC inc             | 33 or 32 Power |
| 8 MAP 5V              | 9 Sensor       |
| 10 Oil Temp           | 17 Sensor      |
| 12 TPS Sig            | 34 Sensor      |
| 13 Sensor GND         | 23 Sensor      |
| 14 Air Temp           | 7 Sensor       |
| 15 Water Temp         | 25 Sensor      |
| 18 TPS 5 V            | 9 Sensor       |
| 20,21,22,33 See Below |                |
| 23 VVC Decrease       | 5 Power        |
| 25 Coil 2             | 18 Power       |
| 26 Coil 1             | 10 Power       |
| 27 +12V               | 31 Power       |
| 28 Fan 1              | 4 Power        |
| 30 Fuel Pump          | 3 Power        |
| 36 MAP Sig            | 16 Sensor      |

Ignition Relay Black Con.      Relay

|         |         |
|---------|---------|
| 20 & 21 | 85 & 87 |
| 22      | 30      |
| 33      | 86      |

S60 Power Con Pins 13 & 14 To Bat Negative

## Honda CBR600 F4i Sequential

**General Engine Settings, Flywheel Mode 10  
Requires Firmware V19.02 or higher.**

Any Honda bike engine fitted with the cam wheel  
below and a 12 tooth (no gaps) crank wheel.

Crank Sensor

Pin 1 GND (Yellow/White)  
Pin 2 Signal (Yellow)

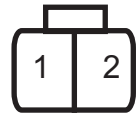

Cam Sensor

Pin 1 Signal (Grey)  
Pin 2 GND (Yellow/White)

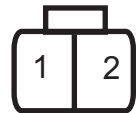

Drawn looking at connector attached to sensor





## Suzuki Hyabusa

All drawn looking at the sensor/actuator, wiring colours are sensor not loom colours

### Crank Sensor

Pin 1 GND (Green)  
Pin 2 Signal (Blue)

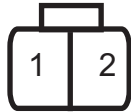

### Cam Sensor

Pin 1 GND  
Pin 2 Signal

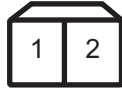

### TPS Sensor

Pin 1 GND  
Pin 2 Signal  
Pin 3 5v

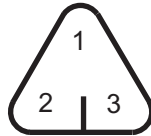

### MAP

Pin 1 = 5V  
Pin 2 = Signal  
Pin 3 = Sensor GND

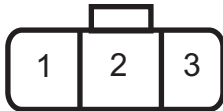

### Gear

Pin 1 = Supply  
Pin 2 = Variable Resistor End  
Pin 3 = Switch to 1



### Resistance Values Ohms

|     |       |
|-----|-------|
| 1st | 560   |
| 2nd | 827   |
| 3rd | 1585  |
| 4th | 2733  |
| 5th | 6800  |
| 6th | 15000 |

## Air Conditioner Connections

12V Control  
To Compressor

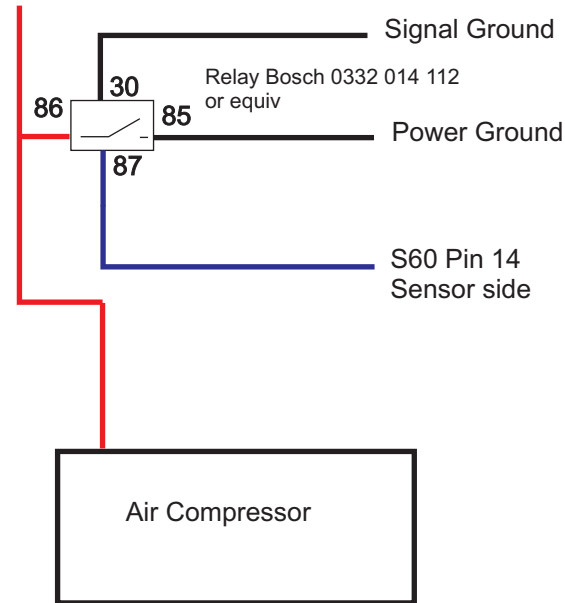

## BMW Mini (Chrysler Engine)

All drawn looking at the sensor/actuator, wiring colours are loom colours

### Crank/Cam Sensors

Pin 1 GND (Brown/Stripe)  
Pin 2 Signal (Black/Stripe)  
Pin 3 12V (Red/Stripe)

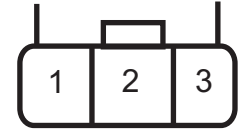

### TPS Sensor

Pin 1 GND  
Pin 2 Signal  
Pin 3 5v

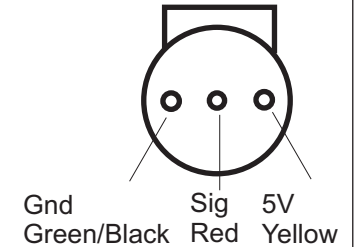

### Coil

Pin 1 Cyl 2 & 3 (Black / Yell)  
Pin 2 12V (Red)  
Pin 3 Cyl 1 & 4 (Black / Blue)

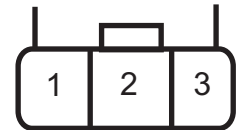

# Orientation of Magnetic Rotating Sensors

## Cam Sensor

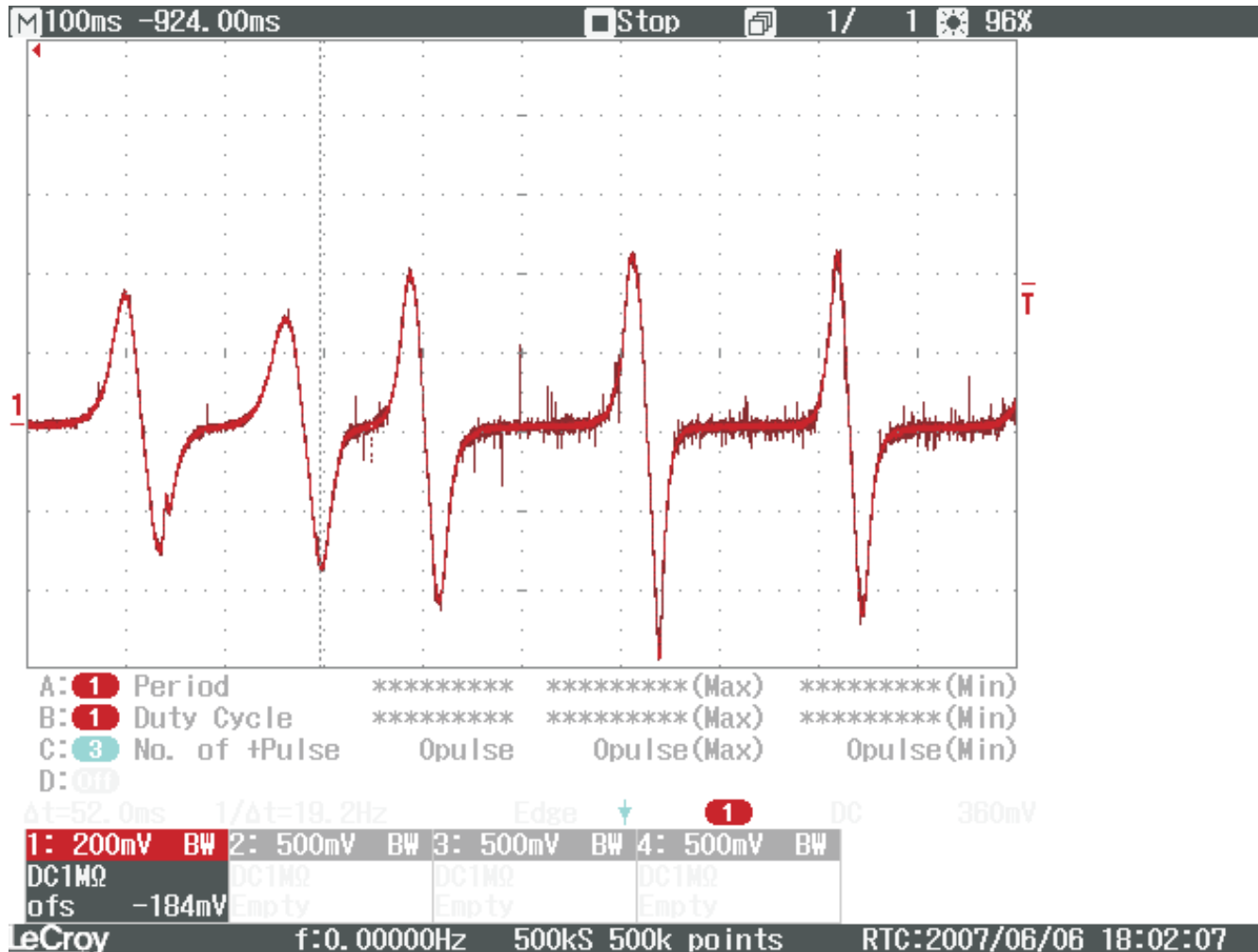

Shown is an oscilloscope trace of a typical magnetic cam sensor pattern when cranking. The orientation is correct when the voltage seen at the signal pin rises as the tooth approaches and falls sharply when the tooth recedes.

If the sensor is connected with reversed polarity then the signal position will appear to move causing cam shaft errors and apparent movement in cam position.

Note the presence of high frequency noise on this signal. This is the result of not using shielded twisted pair wire for this sensor. If this is strong enough cam shaft errors will result and the engine may not run at all.



# Crank Sensor

On the left is an oscilloscope trace of a good clean signal from a magnetic crank sensor on a 36 - 1 wheel. Note the voltage rising through the gap. This is the correct polarity.

If the voltage falls through the gap then the engine may start but at a certain RPM will begin to give crank shaft errors and re-synchronisations.

The voltage variation is caused by successive compression strokes slowing the rotation speed during cranking.

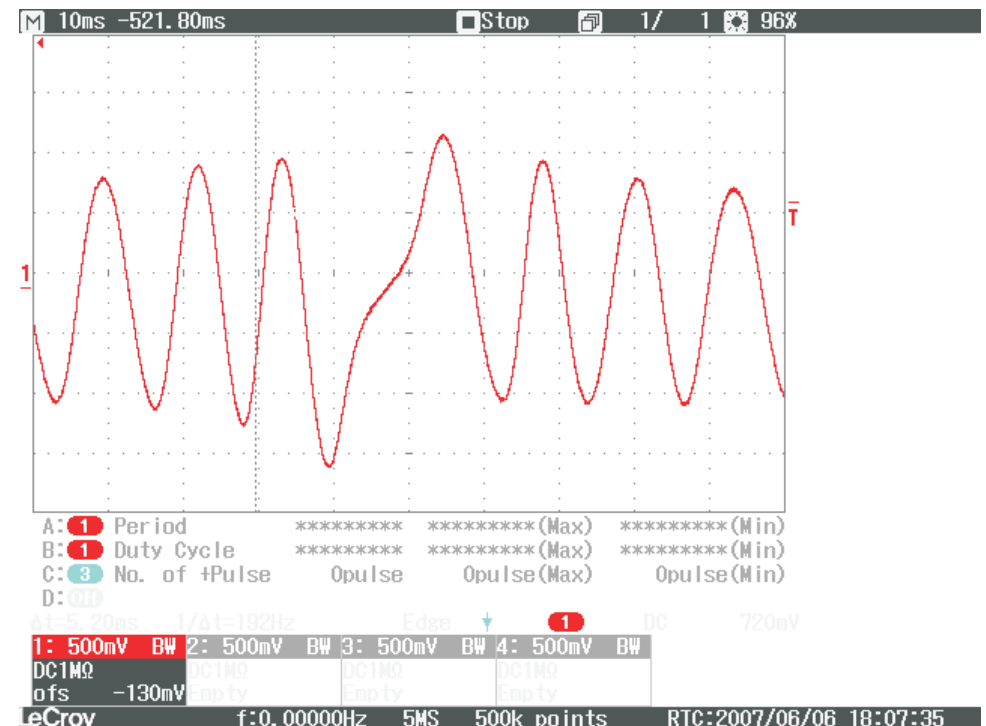

On the right is a more detailed view of the gap itself. Note the voltage rising as the gap traverses the sensor.

You can also see that this signal is free of high frequency noise. The correct screened twisted pair wire has been used for this sensor. Both cam and crank traces are from the same vehicle.